

FRONT

BACK

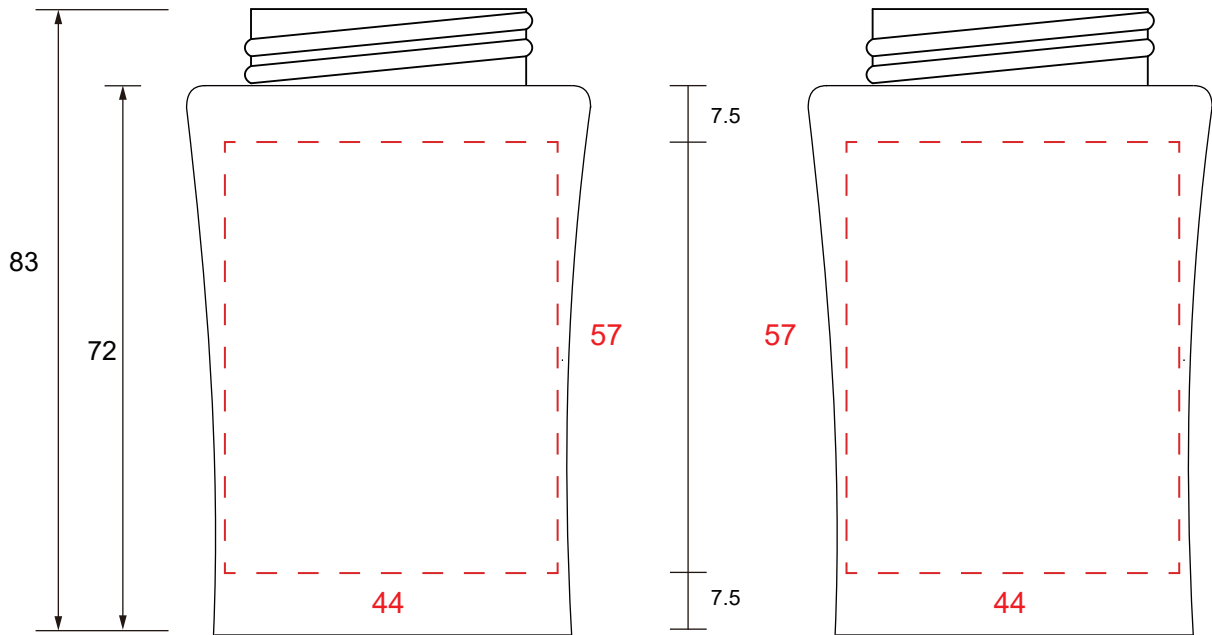

Printing Area 57mm x 44mm

Color

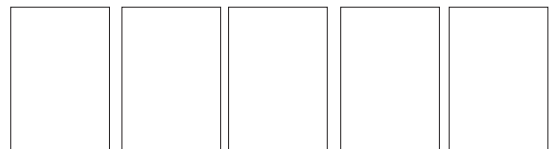

 精美模具有限公司
JINGMEI INDUSTRY CO., LTD

Item No. P-50L

Date:

Customer Confirmation

1. Please confirm the content, layout, and color,
2. Kindly sign and return to us as a confirmation to begin molding
3. Any amendment after signing this document will incur extra fee for molding.
4. All measurements above are in millimeter (mm)